

PRICE LIST

E F F E C T I V E : J U L Y 1 , 2 0 0 3

GL-350 Drywall Replacement System®

Distribution Center:

3540 West TC Jester Blvd.
Houston, Texas 77018
Phone: 800-945-2454
Fax: 877-945-2454

Technical & Sales Information:

Phone: 800-945-2454
Fax: 877-945-2454
E-Mail: blair@gravitylock.com
Website: www.gravitylock.com



TERMS AND CONDITION OF SALE

SALES

All sales are F.O.B. Houston, Texas with title passing to customer upon delivery to carrier.

PRICES

All shipments will be made at prices in effect on date of shipment.

Prices apply F.O.B. Houston, Texas. All freight charges will be for the customer's account.

On all shipments from any other shipping point, all freight charges will be for the customer's account.

Prices are subject to change without notice.

Expedited services will be charged an "expediting fee".

FREIGHT

GLS reserves the right to choose the method of transportation and the carrier.

Requests for a more costly method of shipment will be honored, provided the customer agrees to pay all freight charges.

TERMS OF PAYMENT

All invoices net thirty days.

Interest of 1.5% per month will be charges on overdue accounts.

NON STANDARD LENGTHS & COLORS

On a written quotation basis only.

NOTICE:

GL-350 components are manufactured to close specifications. The use of standard "C" studs and track from other manufacturers is not recommended and could result in difficulties in the installation of GL-350 door frames and glazing components.

LIMITED WARRANTY:

Gravity Lock Systems' sole warranty to the customer is that each product manufactured and sold by Gravity Lock Systems shall, at the time of shipment, be fit for the ordinary purpose for which such product is customarily used. THIS WARRANTY IS IN LIEU OF ALL OTHER WARRANTIES, EXPRESSED OR IMPLIED, INCLUDING WARRANTIES OF MERCHANTABILITY AND FITNESS FOR A PARTICULAR PURPOSE

REMEDIES:

Gravity Lock Systems shall be responsible or liable only for replacement of or, at Gravity Lock's option, refund of purchase price of Gravity Lock components which do not meet the limited warranty set forth above, but in no event shall Gravity Lock be liable for any amount in excess of the purchase price of the goods, nor shall Gravity Lock Systems be liable for any incidental or consequential damages.

GL35-350 ITEM NO. 1100 STUD SELECTION CHART



Ceiling Height	Stud Length	Ceiling Height Range	Weight	Panel Clip Spacing	Prices	Lead Time
8'-0"	91 $\frac{1}{4}$ " (7'-7 $\frac{1}{4}$ ")	7'-11" to 8'-5"	4.40	3 @ 26"	15.25	In Stock
8'-6"	97 $\frac{1}{4}$ " (8'-1 $\frac{1}{4}$ ")	8'-5" to 8'-11"	4.68	3 @ 26"	16.20	In Stock
9'-0"	103 $\frac{1}{4}$ " (8'-7 $\frac{1}{4}$ ")	8'-11" to 9'-5"	4.95	3 @ 26"	17.15	In Stock
9'-6"	109 $\frac{1}{4}$ " (9'-1 $\frac{1}{4}$ ")	9'-5" to 9'-11"	5.23	4 @ 24"	18.10	In Stock
10'-0"	115 $\frac{1}{4}$ " (9'-7 $\frac{1}{4}$ ")	9'-11" to 10'-5"	5.50	4 @ 24"	19.05	In Stock
12'-0"	139 $\frac{1}{4}$ " (11'-7 $\frac{1}{4}$ ")	11'-11" to 12'-5"	6.60	5 @ 24"	22.95	In Stock

Other lengths available - ON REQUEST

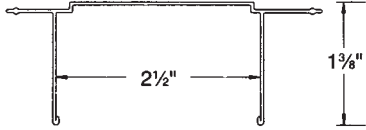
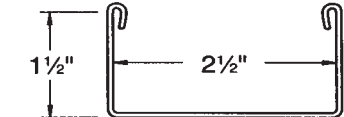
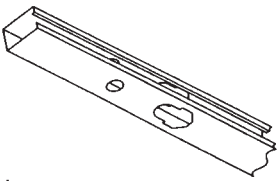
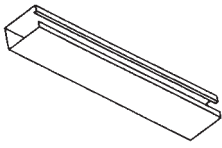
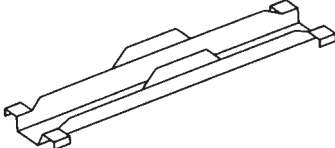
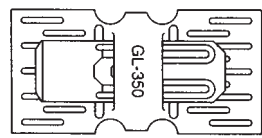
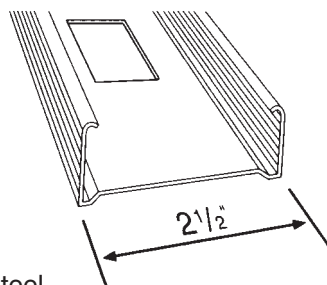

FRAMING COMPONENTS

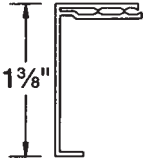
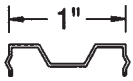
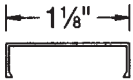
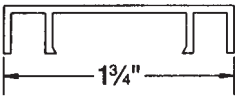
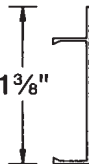
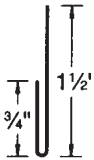
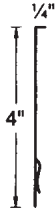
Code	Product Description	Color	Notes	Size	PCS/CTN	Weight	Unit	Price	Lead Time	Quantity Required
1000	<p>CEILING RUNNER</p>  <p>Steel</p>		SOLD IN FULL BUNDLES ONLY	10"	10	4.75	EACH	15.65	IN STOCK	
1050	<p>HEMMED GL350 FLOOR TRACK</p>  <p>Steel</p>		SOLD IN FULL BUNDLES ONLY	10"	10	3.90	EACH	11.55	IN STOCK	
1100	<p>GL-STUD</p>  <p>Steel</p>		SOLD IN FULL BUNDLES ONLY	SEE STUD CHART	10	SEE CHART	EACH	SEE STUD CHART	IN STOCK	
1150	<p>GL-EXTENSION</p>  <p>Steel</p>			13'	48	.790	EACH	3.55	IN STOCK	
1200	<p>GL-CROSS CHANNEL</p>  <p>Steel</p>			11"	60	.320	EACH	2.00	IN STOCK	
1250	<p>CLIP SET</p>  <p>Steel</p>			2" x 4"	350	.097	EACH	.80	IN STOCK	
4010	<p>GL-350 C STUD</p>  <p>Steel</p>		25 GAGE SOLD IN FULL BUNDLES ONLY	8'	10	3.10	EACH	5.10	IN STOCK	
9'				3.49		5.65				
10'				3.87		6.20				
12'				4.64		7.44				
4015			20 GAGE SOLD IN FULL BUNDLES ONLY	10	8'	4.16	10.60	EACH	IN STOCK	
9'					4.75	11.90				
10'					5.20	13.10				
12'					6.24	15.72				

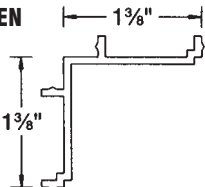

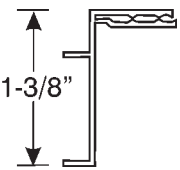
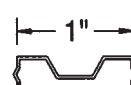

PVC TRIM COMPONENTS

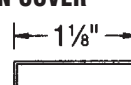
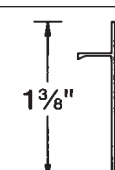
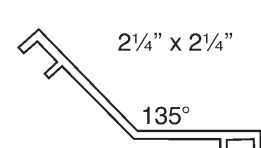
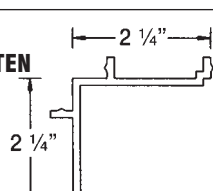
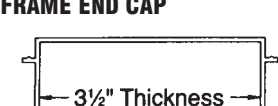
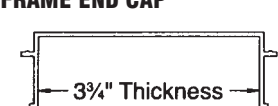
Code	Product Description	Color	Notes	Size	PCS/CTN	Weight	Unit	Price	Lead Time	Quantity Required
2000	CEILING TRIM PVC 	Gray Bronze Putty Black Clay Tan Wintersgate		10'	100	.62	EACH	7.08	IN STOCK	
2080	STEEL BATTEN Steel 		SPECIFY LENGTH WHEN ORDERING	8'-5" 9'-5"	50	.81 .91	EACH	5.85 6.50	IN STOCK	
2120	BATTEN COVER PVC 	Gray Bronze Putty Black Clay Tan Wintersgate	SPECIFY LENGTH WHEN ORDERING	9' 10'	170	.36 .40	EACH	3.45 3.85	IN STOCK	
2125	MONO WIDE BATTEN COVER PVC 	Gray Bronze Putty Black Clay Tan Wintersgate	SPECIFY LENGTH WHEN ORDERING	9' 10'	112	.62	EACH	6.85 7.60	2 Weeks	
2240	MOC CEILING TRIM COVER PVC 	Gray Bronze Putty Black Clay Tan Wintersgate		9'	150	.48	EACH	5.20	IN STOCK	
2320	BASE J-HOOK Steel 			8'	50	1.11	EACH	6.50	IN STOCK	
2360	4" BASE PVC 	Gray Bronze Putty Black Clay Tan Wintersgate		8'	60	1.08	EACH	13.45	IN STOCK	
2365	BASE CORNER PVC 	Gray Bronze Putty Black Clay Tan Wintersgate		12" x 12"	20	.566	EACH	11.00	IN STOCK	
2400	CORNER BATTEN PVC 	Gray Bronze Putty Black Clay Tan Wintersgate	SPECIFY LENGTH WHEN ORDERING	9' 10'	50	.90 1.00	EACH	9.25 10.35	IN STOCK	



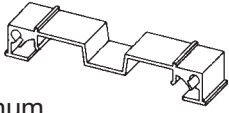

ALUMINUM TRIM COMPONENTS

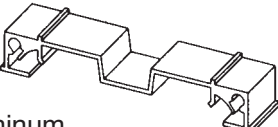
Code	Product Description	Color	Notes	Size	PCS/CTN	Weight	Unit	Price	Lead Time	Quantity Required
2000R	CEILING TRIM RETAINER PVC 	Gray Bronze Putty Black Clay Tan Wintersgate	USE WITH 2225	10'	100	.075	EACH	7.40	IN STOCK	
2080	STEEL BATTEN Steel 		SPECIFY LENGTH WHEN ORDERING	8'-5" 9'-5"	50	.81 .91	EACH	5.85 6.50	IN STOCK	
2130	ALUMINUM WIDE BATTEN COVER Aluminum 	Gray Bronze Putty Black Clay Tan Wintersgate Satin	SPECIFY LENGTH WHEN ORDERING	9' 10'	50	1.5 2.0	EACH	11.30 12.55	2 Weeks	
2200	ALUMINUM BATTEN COVER Aluminum 	Gray Bronze Putty Black Clay Tan Wintersgate Satin	SPECIFY LENGTH WHEN ORDERING	9' 10'	120	.72 .80	EACH	10.80 11.30	IN STOCK	
2225	ALUMINUM MOC CEILING TRIM Aluminum 	Gray Bronze Putty Black Clay Tan Wintersgate Satin		10'	150	2.0	EACH	14.65	IN STOCK	
2435	ALUMINUM 135° CORNER Aluminum 	Gray Bronze Putty Black Clay Tan Wintersgate Satin		9' 10'	35	.44 .50	EACH	27.15 30.15	IN STOCK	
2490	ALUMINUM CORNER BATTEN Aluminum 	Gray Bronze Putty Black Clay Tan Wintersgate Satin		9' 10'	35	.34 .38	EACH	27.15 30.15	IN STOCK	
3240	3/2" FRAME END CAP Aluminum 	Gray Bronze Putty Black Clay Tan Wintersgate Satin	SPECIFY LENGTH WHEN ORDERING	9' 10'	20	4.41 4.90	EACH	49.10 54.45	4 Weeks	
3270	3/4" FRAME END CAP Aluminum 	Gray Bronze Putty Black Clay Tan Wintersgate Satin	SPECIFY LENGTH WHEN ORDERING	9' 10'	20	4.64 5.15	EACH	52.50 58.20	IN STOCK	

GLAZING-FRAME COMPONENTS

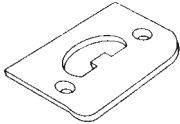
Code	Product Description	Color	Notes	Size	PCS/CTN	Weight	Unit	Price	Lead Time	Quantity Required
3000	3½" FRAME SECTION  Aluminum	Gray Bronze Putty Black Clay Tan Wintersgate Satin	SPECIFY LENGTH WHEN ORDERING	9'	20	6.12	EACH	64.50	4 Weeks	
				12'-3"		8.37		87.80		
3030	3½" FRAME INSERT  Aluminum	Gray Bronze Putty Black Clay Tan Wintersgate Satin	SPECIFY LENGTH WHEN ORDERING	9'	26	4.23	EACH	46.65	4 Weeks	
				12'-7"		5.97		65.25		
3060	3½" FRAME CLIP  Aluminum			3½" x ¾"	50	.066	EACH	1.10	4 Weeks	
3090	3¾" FRAME SECTION  Aluminum	Gray Bronze Putty Black Clay Tan Wintersgate Satin	SPECIFY LENGTH WHEN ORDERING	9'	20	6.26	EACH	66.00	In Stock	
				12'-3"		8.55		90.25		
3120	3¾" FRAME INSERT  Aluminum	Gray Bronze Putty Black Clay Tan Wintersgate Satin	SPECIFY LENGTH WHEN ORDERING	9'	26	4.44	EACH	48.40	In Stock	
				12'-7"		6.27		67.80		
3150	3¾" FRAME CLIP  Aluminum			3¾" x ¾"	50	.071	EACH	1.15	In Stock	

DOOR & GLAZING COMPONENTS

Code	Product Description	Color	Notes	Size	PCS/CTN	Weight	Unit	Price	Lead Time	Quantity Required
3180	DOOR STOP  PVC	Gray Bronze Putty Black Clay Tan Wintersgate		9'	50	1.35	EACH	22.90	In Stock	
3210	NYLON STRIKE PLATE  Nylon	Gray Bronze Putty Black Clay Tan Wintersgate		2 3/4"	50	.016	EACH	2.20	In Stock	
3330	HEADER GLASS STOP  PVC	Gray Bronze Putty Black Clay Tan Wintersgate		10'	50	.85	EACH	8.80	In Stock	
3360	GLAZING BEAD FOR: (3/16") GLASS  PVC	Gray Bronze Putty Black Clay Tan Wintersgate		3/16" Glass	800'	.056 Rolls	Linear Foot	.62	4 Weeks	
3390	GLAZING BEAD FOR: (1/4") GLASS  PVC	Gray Bronze Putty Black Clay Tan Wintersgate		1/4" Glass	800'	.045 Rolls	Linear Foot	.50	In Stock	

DOOR FRAME KITS: ALUMINUM-PVC STOP & TRIMS

Code	Product Description	Color	Notes	Size	PCS/CTN	Weight	Unit	Price	Lead Time	Quantity Required
5000	3½" FRAME - 3' x 7' Hinges Excluded	Gray Bronze Putty Black Clay Tan Wintersgate Satin		3' x 7'	4	18	EACH	194.00	4 Weeks	
5020	3½" FRAME - 3' x 9' Hinges Excluded	Gray Bronze Putty Black Clay Tan Wintersgate Satin		3' x 9'	4	19	EACH	220.00	4 Weeks	
5040	3¾" FRAME - 3' x 7' Hinges Excluded	Gray Bronze Putty Black Clay Tan Wintersgate Satin		3' x 7'	4	19	EACH	198.00	In Stock	
5060	3¾" FRAME - 3' x 9' Hinges Excluded	Gray Bronze Putty Black Clay Tan Wintersgate Satin		3' x 9'	4	20	EACH	231.00	In Stock	

NOTE: Aluminum/PVC door frames kits include hinge and strike jambs, header, PVC trims and PVC strike plate.
Frames are non-handed and reversible

Sliding aluminum door frames available upon request. Glass and glazing furnished and installed by others.

DOOR FRAME KITS: ALUMINUM ELITE FRAMES WITH PVC TRIMS



Code	Product Description	Color	Notes	Size	PCS/CTN	Weight	Unit	Price	Lead Time	Quantity Required
5260	3¾" ALL ALUMINUM FRAME - 3' x 7' Hinges Included	Gray Bronze Putty Black Clay Tan Wintersgate Satin		3' x 7'	4	19	EACH	225.00	4 Weeks	
5300	3¾" ALL ALUMINUM FRAME - 3' x 9' Hinges Included	Gray Bronze Putty Black Clay Tan Wintersgate Satin		3' x 9'	4	21	EACH	258.00	4 Weeks	

All frames can be specially mortised for your convenience.

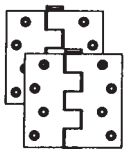
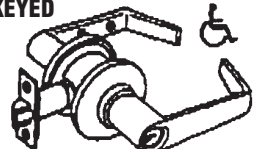

Series 5200 to 5300 hinges and strikes are installed for your convenience.

Aluminum battens are extra for all frames. Frames are designed for 1¾" doors.

DOOR HARDWARE

Code	Product Description	Color	Notes	Size	PCS/CTN	Weight	Unit	Price	Lead Time	Quantity Required
3300	4½" x 4½" BALL BEARING HINGES Steel 	Satin Bronze	SPECIFY COLOR WHEN ORDERING	4½" x 4½"	EACH	1.6	EACH	12.00	In Stock	
6005	SCHLAGE KEYED LOCKSET AL53LD 	26D Satin			1		EACH	184.00	In Stock	
6010	WALL MOUNT DOOR STOP CONCAVE 	Satin		2-3/8" Dia. 11/16" Deep	1		EACH	5.50	In Stock	

DOORS

Code	Product Description	Color	Notes	Size	PCS/CTN	Weight	Unit	Price	Lead Time	Quantity Required
7000	3' x 7' SOLID CORE WOOD DOOR - Flush Plastic Laminated Faces, Painted Edges 	Mizar Oak Montana Walnut Figured Mahogany Designer Teak Light Tarragona Oak	SPECIFY RH or LH	NOM. 3'x7'	1	110#	EACH	410.00	2 - 4 Weeks	
7100	3' x 9' SOLID CORE WOOD DOOR - Flush Plastic Laminated Faces, Painted Edges 	Mizar Oak Montana Walnut Figured Mahogany Designer Teak Light Tarragona Oak	SPECIFY RH or LH	NOM. 3'x9'	1	140#	EACH	525.00	2 - 4 Weeks	

DOOR SPECIFICATIONS:

Standard 3'-0" x 7' and 3'-0" x 9' doors are 1¾" thick solid core wood doors with plastic laminate faces and painted edges. For pricing of stain/paint grade birch and red oak veneer doors, other size doors, and pairs of doors, contact Houston for pricing and availability.

Doors are premachined for 3 each (for 7' door) or 4 each (for 9' door) of 4 ½" x 4 ½" standard weight ball bearing hinges. Hinge backset on door is ¼". Doors are mortised for standard Schlage AL53LD lockset. Contact Houston for pricing and availability of Federal #86 mortising.

Wood veneer and vision lites available. Glass and glazing is NOT included in the price of door with vision lites.

Doors orders must specify door hand (either right hand or left hand). Pairs of doors must specify active leaf. Doors are laminated with Wilsonart brand laminate. Other colors are available at additional cost. Contact Houston for pricing and availability.



DOOR NOTES:

All door orders are subject to a \$75.00 set-up charge for mortising. All door orders are subject to a crating charge of \$40.00 per crate. (10 doors maximum per crate).

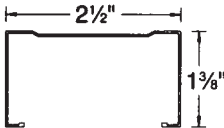
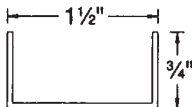
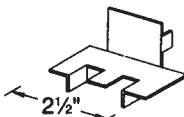
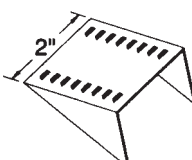

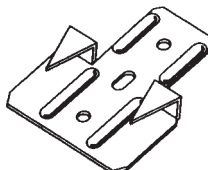

ONE HOUR FIRE-RATED COMPONENTS

Code	Product Description	Color	Notes	Size	PCS/CTN	Weight	Unit	Price	Lead Time	Quantity Required
4000	2½" FIRE RATED STUD  Steel		SOLD IN FULL BUNDLES ONLY SPECIFY LENGTH WHEN ORDERING	9'	10	3.49	EACH	13.00	In Stock	
				10'		3.87		14.60		
4025	1½" REINFORCING CHANNEL  Steel		SPECIFY LENGTH WHEN ORDERING	10'	10	4.00	EACH	12.10	In Stock	
				5'		2.00		6.40		
4050	STUD SPACER  Steel			1½"	200	.045	EACH	.36	In Stock	
4075	STUD SHIM  Steel			1" x 1¼"	350	.079	EACH	.55	In Stock	

CLIPS

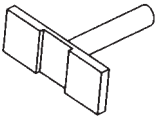
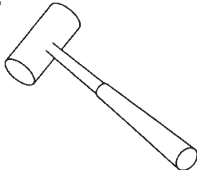
Code	Product Description	Color	Notes	Size	PCS/CTN	Weight	Unit	Price	Lead Time	Quantity Required
4080	EDGE CLIP  Steel				1000 with 500 Screws	13	CTN.	247.00	In Stock	
4085	CEILING GRID CLIP  Steel				100	.05	EACH	1.45	In Stock	

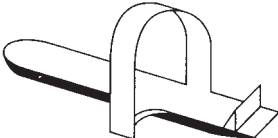
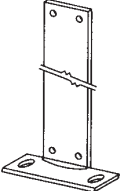
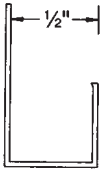
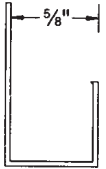
ACCESSORIES: MISCELLANEOUS ITEMS

Code	Product Description	Color	Notes	Size	PCS/CTN	Weight	Unit	Price	Lead Time	Quantity Required
6000	CLIP TOOL  Steel				1	2.60	EACH	66.00	In Stock	
6015	POWERDRIVE MALLET 				1	3.00	EACH	92.40	In Stock	
6030	TOUCH UP PAINT 	Gray Bronze Putty Black Clay Tan Wintersgate			1	13 oz.	EACH	36.60	In Stock	
6045	ALUMINUM PANEL LIFTER 				1	1.5	EACH	51.70	In Stock	
6060	ANCHOR POST  Steel			24" High	5	3.50	EACH	41.80	In Stock	
6075	1/2" BASE CLIP  PVC	Bronze		47"	70	.25	EACH	2.90	4 Weeks	
6090	5/8" BASE CLIP  PVC	Bronze		47"	60	.25	EACH	3.20	In Stock	
6105	FRAME INSERT STRIP  PVC	Gray Bronze Putty Black Clay Tan Wintersgate		9"	150	.18	EACH	2.65	In Stock	

ACCESSORIES: MISCELLANEOUS ITEMS (CONTINUED)

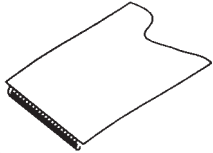
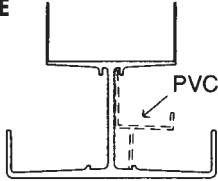
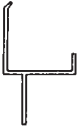
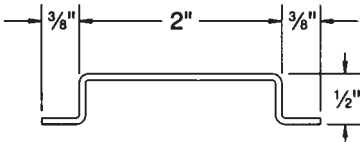
Code	Product Description	Color	Notes	Size	PCS/CTN	Weight	Unit	Price	Lead Time	Quantity Required
6120	FOAM SEAL  1/8" x 1-1/4"		SOLD IN FULL ROLLS ONLY	100'	16 rolls	.813	ROLL	33.00	In Stock	
6150	VELCRO TAPE 1"  For Carpet		SOLD IN FULL ROLLS ONLY	75'	1		ROLL	110.00	In Stock	
6165	SELF TAPPING HINGE SCREWS	Satin Bronze	SPECIFY COLOR WHEN ORDERING	3/4"	500	.005	EACH	.24	In Stock	
8110	HORIZONTAL CHASE BASE ASSEMBLY  Aluminum		SPECIFY WIDTH WHEN ORDERING	3 1/2" x 10"	2	14	EACH	113.00	4 Weeks	
				3 3/4" x 10"				115.00	In Stock	
8120	CABLE SUPPORT  PVC			5'	20	4.25	EACH	9.50	In Stock	
8130	FURNITURE HANGING CHANNEL  Steel			9'	10	4.00	EACH	16.50	In Stock	
6165	DOUBLE ADHESIVE TAPE 1/8" x 1-1/2" x 75' For Vinyl Floors		SOLD IN FULL ROLLS ONLY	75'	1	.200	ROLL	57.50	In Stock	

WALL PANELS

GYPSUM PANELS

Panel Descriptions	1-12 Pieces	13-50 Pieces	Pattern	Point of Origin	Lead Time	Quantity Required
VINYL CLAD GYPSUM: Group I: 1/2" x 48" panel 5/8" x 48" panel	1.15 S/F	1.10 S/F	Savannah	Houston	6 Weeks for 1/2" Panel	
	1.25 S/F	1.17 S/F			2-4 Weeks for 5/8" Panel	
VINYL CLAD GYPSUM: Group II: 1/2" x 48" panel 5/8" x 48" panel	1.36 S/F	1.32 S/F	Cimarron Napa	Houston	6 Weeks for 1/2" Panel	
	1.43 S/F	1.36 S/F			2-4 Weeks for 5/8" Panel	
VINYL CLAD GYPSUM: Group III: 1/2" x 48" panel 5/8" x 48" panel	1.45 S/F	1.41 S/F	Hatteras Tejas	Houston	6 Weeks for 1/2" Panel	
	1.52 S/F	1.48 S/F			2-4 Weeks for 5/8" Panel	
VINYL CLAD GYPSUM: Group IV: 1/2" x 48" panel 5/8" x 48" panel	1.54 S/F	1.50 S/F	Catalina	Houston	6 Weeks for 1/2" Panel	
	1.61 S/F	1.56 S/F			2-4 Weeks for 5/8" Panel	
VINYL CLAD GYPSUM: Group V: 1/2" x 48" panel 5/8" x 48" panel	1.63 S/F	1.58 S/F	Hamptons	Houston	6 Weeks for 1/2" Panel	
	1.69 S/F	1.65 S/F			2-4 Weeks for 5/8" Panel	
FABRIC WRAPPED GYPSUM: 5/8" x 48" panel	4.00 S/F	3.60 S/F	FR 701 Fabric	Houston	4 Weeks	

ACCOUSTICAL PANELS: MAXIMUM LENGTH 120"

QUIET TOUCH PANELS: Honeycomb Core with Fiberglass-Fabric Cover. (.90 NRC) 5/8" x 48" panel	13.50 S/F	11.55 S/F	FR 701 Fabric	Columbus, Ohio	2-4 Weeks	
SOUND TOUCH PANELS: Gypsum and Fiberglass Covered with Fabric. (.40 NRC) 5/8" x 48" panel	12.17 S/F	11.00 S/F	FR 701 Fabric	Houston, Texas	2-4 Weeks	

NOTE: Special length and width panels not shown above are available on a special quote basis. Contact Houston for availability, pricing and lead times.

A \$80.00 crating charge will be applied in increments of 40 panels of vinyl or fabric covered gypsum panels if less than truckload quantity. Contact Houston for orders over 80 pieces to determine if panels will be shipped LTL or Flatbed.

WALL PANELS

STEEL COVERED PANELS: MAXIMUM LENGTH 120"

Panel Descriptions	1-12 Pieces	13-50 Pieces	Panel Finish	Point of Origin	Lead Time	Quantity Required
STEEL PANEL: 1/2" x 48" panel	7.37 S/F	6.60 S/F	Polyester	Greensboro, NC	4-6 Weeks for 1/2" Panel	
5/8" x 48" panel	7.60 S/F	6.82 S/F			4-6 Weeks for 5/8" Panel	
STEEL PANEL: 1/2" x 48" panel	7.81 S/F	7.04 S/F	6 Mil. Vinyl Covered	Greensboro, NC	4-6 Weeks for 1/2" Panel	
5/8" x 48" panel	8.03 S/F	7.26 S/F			4-6 Weeks for 5/8" Panel	
HOMOSOTE ACOUSTICAL PANEL: 5/8" x 48" panel	Contact Houston for Pricing	Contact Houston for Pricing	Fabric Wrapped	Houston, Texas	4 Weeks for 5/8" Panel	

SPECIALTY PANELS: MAXIMUM LENGTH 120"

HIGH ABUSE GYPSUM PANEL: 15 Mil. Vinyl covered 5/8" x 48" panel	Contact Houston for Pricing	Contact Houston for Pricing		Houston, Texas	4 Weeks	
MAGNETIC WRITER PANEL: 5/8" x 48" panel	Contact Houston for Pricing	Contact Houston for Pricing		Houston, Texas	4 Weeks	

NOTE: Special length and width panels not shown above are available on a special quote basis. Contact Houston for availability, pricing and lead times.

ARCHITECTURAL SPECIFICATIONS

GL-350 Drywall Replacement System

Part 1 - General

1.01 Related Work

- A. Related work specified elsewhere:
1. Section _____ Conventional doors and glass frames.
 2. Section _____ Glazing
 3. Section _____ Painting

1.02 System Description

- A. Complete interior wall system, 3-3/4" thick (3-1/2" option available), to include doors, door frames, glazed opening, hardware, PVC or aluminum trims and base.

1.03 Quality Assurance

- A. Manufacturer to certify that all materials meet or exceed these specifications.
- B. Installing contractor shall be registered and licensed by the manufacturer.
- C. Sound transmission: Provide independent laboratory certification that the wall system proves a 35-39 STC with unpacked cavity, and 45-49 STC with 2-1/2" insulation in cavity when tested in accordance with ASTM E90.
- D. Point accessibility: System design shall allow for all panels (excluding some glazing conditions) to be point accessible without affecting adjoining panels.
- E. Surface Burning Characteristics: Provide independent laboratory certification that the wall system has a Flame Spread Index not to exceed 15, and Smoke Developed not to exceed 20 when tested in accordance with ASTM E84-95.

Part 2 - Products

2.01 Manufacturer

- A. GL-350 Drywall Replacement System as manufactured by Gravity Lock Systems, Inc., Houston, Texas.

2.02 Materials

- A. Framing
1. Top track - Roll formed steel with hemmed legs designed to accept snap-on, snap-off PVC ceiling trim from either side of the wall.
 2. Floor track - Horizontal wiring chase, extruded aluminum (6063-T5) with minimum .125 vertical cross section for system support. Includes integral legs to accept snap-on, snap-off 4" or 2-1/4" base molding.
 3. Stud framing: "U" shaped stud with 11" cross locking channels and roll formed standard "C" studs.
- B. Panels
1. System design shall accommodate a variety of panels including vinyl clad gypsum, fabric clad gypsum, steel clad gypsum and sound control panels.
 2. Panels shall be decorated in manufacturer's standard vinyl and fabric coverings.
 3. All panels shall be point accessible and capable of being replaced with panels of a different core or face covering. System design shall allow for different types of panels to be installed on opposite sides of the wall.
- C. Glazing components
1. Glazing components shall be aluminum (6063-T5) and shall integrate with ceiling track and door frames. Glass furnished and installed by others.

- D. Door frames
1. Aluminum (6063-T5) door frames in 7' and 9' standard opening heights designed to integrate with ceiling track and glazing.
- E. Hardware
1. Hinges shall be 4-1/2" x 4-1/2" ball bearing hinges.
 2. Lockset shall be thru-bolt cylindrical AL53LD, light duty, key entry, #26D finish, ADA approved.
- F. Doors
1. Doors to be 1-3/4" solid core wood doors with Wilsonart brand plastic laminate faces and painted edges. Door options include unfinished birch, cherry and red oak veneer in lieu of plastic laminate.
- G. Trims
1. Battens, base, ceiling trim and corners are PVC or aluminum snap-on type, available in 7 standard colors.
- H. Furniture support
1. System design shall support cabinetry manufactured by all major furniture system companies. System design shall meet all B.I.F.M.A. requirements for loading capacity, provided it is installed according to manufacturer's installation instructions. Loading capacity shall accommodate up to 500 lbs. per 4' standard.
- I. Electrical
1. System design shall support 2-1/2" modular or standard electrical components.

Part 3 - Execution

3.01 Inspection

- A. Prior to partition installation, verify that floor and ceilings are level and ready to accept partition. Facility should be clean, dry and protected from outside weather.

3.02 Installation

- A. Erect partitions plumb and square, accurately fitting to suspended ceiling and over floor coverings. Adjust to correct for any floor irregularities.
- B. At carpeted floors, use fasteners that rigidly secure the partition without damaging or defacing carpeting. At suspended ceiling use fasteners that rigidly secure the partition without defacing or damaging the grid or acoustical tiles. Mechanically fasten the floor track to the substrate at both sides of door frames, finished ends and other areas where rigidity is required.
- C. Position "U" studs vertically in floor and ceiling tracks on 4' centers. Position "C" studs on 4' centers at midpoints between "U" studs. Install cross channels in "U" studs per manufacturer's instructions.
- D. Install panel clips in accordance with manufacturer's instructions. Hang panels on framework taking care to seat all panels on cross channels.
- E. Cut and fit panels to fit neatly to existing walls, window mullions and building columns. Butt panels together to ensure a tight, single line joint.
- F. Install ceiling trims, base molding, corners and other trims in accordance with manufacturer's instructions.

For additional specifications and technical information contact Gravity Lock Systems at 1-800-945-2454.

PROJECT INFORMATION SHEET

GL-350 Drywall Replacement System

Date: _____

Project Name: _____

Location: _____

Start Date: _____

Estimated Completion Date: _____

Job Contact: _____

“Ship to” Address: _____

Description of work: _____

System Information

Ceiling Height: _____

Ceiling Type: _____

Floor Covering: _____

L/F of Solid Wall: _____

L/F of Glazed Wall: _____

STC Requirement: _____

Panel Finish: Vinyl _____ Fabric _____ Sound Control _____

Panel Color: _____

Trim & Glazing Color: Black _____ Grey _____ Clay _____ Bronze _____
Tan _____ Putty _____ Wintersgate _____

Door Frame Size: _____

Furniture Interface: Yes _____ No _____

Additional Information: _____

